



Real-Time Systems

Part 4: Communication

Content

1. Requirements
2. OSI Model
3. Network Topologies
4. Media Access Control Methods
5. Communication Protocols
 - a. SPI
 - b. TTA (TTP/A, TTP/C)
 - c. CAN
 - d. Realtime-Ethernet
 - e. Flexray

Requirements

- In comparison to standard-systems, realtime systems have different requirements for the communication:
 - Deterministic latencies
 - Small jitter
 - Guaranteed bandwidth
 - Efficient protocols, short latencies
 - Fault tolerance
- Criteria for the selection of a communication protocol:
 - Maximum bandwidth
 - Maximum network size (number of nodes, length of physical connections)
 - Costs, availability of components

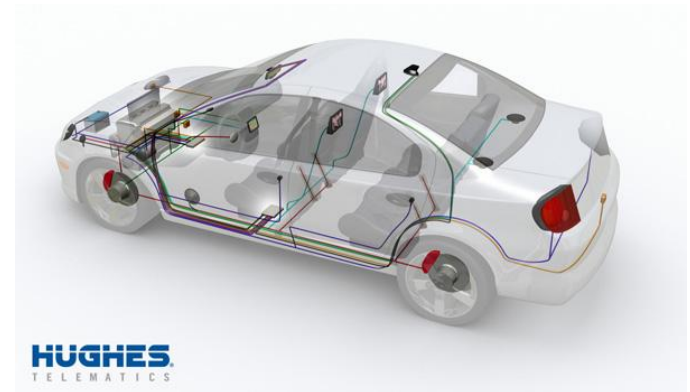
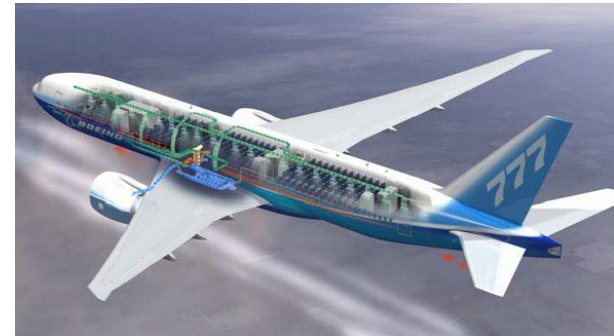

Content

1. Requirements
2. OSI Model
3. Network Topologies
4. Media Access Control Methods
5. Communication Protocols
 - a. SPI
 - b. TTA (TTP/A, TTP/C)
 - c. CAN
 - d. Realtime-Ethernet
 - e. Flexray

Open Systems Interconnection (OSI) Model

- OSI is a 7-layer abstraction model for standardizing the functions of communication systems
- Standardized by the International Organization for Standardization (ISO): ISO/IEC 7498-1
- OSI Layers exchange Service Data Units (SDUs)
- Peers exchange Protocol Data Units (PDUs)

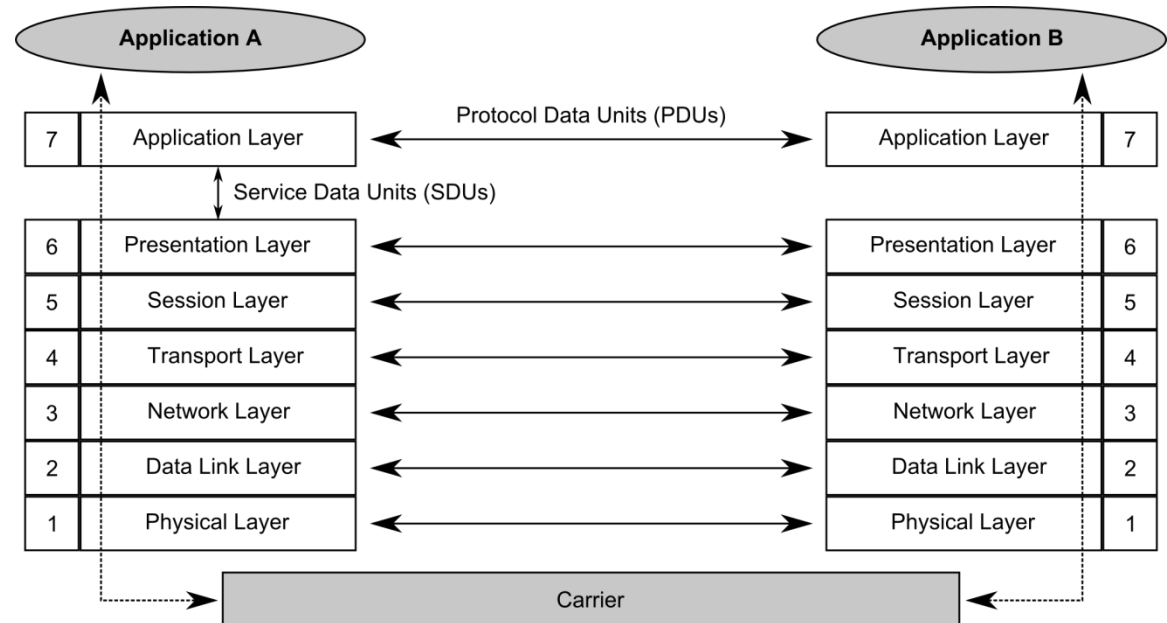

Open Systems Interconnection (OSI) Model

- OSI is a 7-layer abstraction model for standardizing the functions of communication systems
- Standardized by the International Organization for Standardization (ISO): ISO/IEC 7498-1
- OSI Layers exchange Service Data Units (SDUs)
- Peers exchange Protocol Data Units (PDUs)
- **In real-time systems typically only *three* layers are implemented**

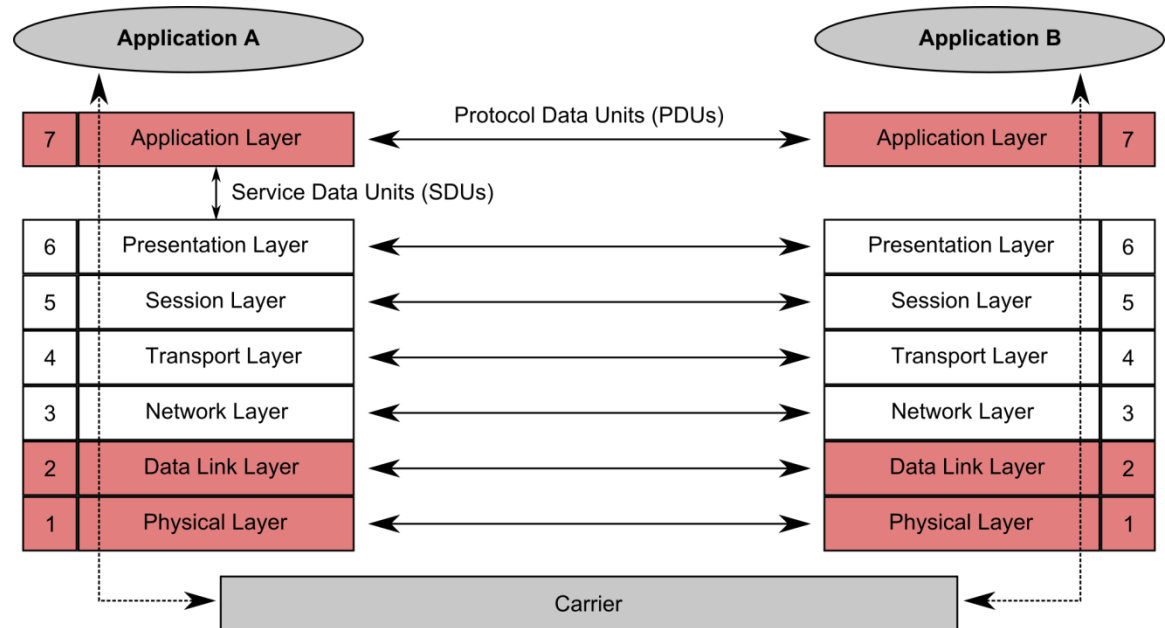

OSI Model: Physical Layer

- Conveys the bit stream (e.g. electrical impulse, light or radio signal)
- Defines electrical, mechanical, functional and procedural properties of physical connection (e.g. plugs and cables)
- Defines encoding
- Important encodings:
 - NRZ (Non-Return-To-Zero)
 - Manchester

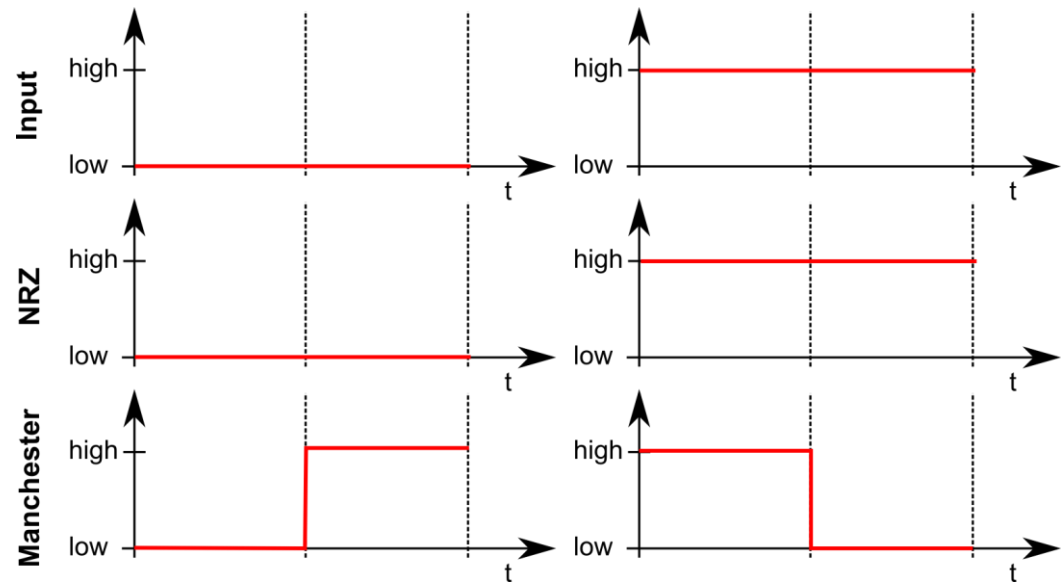

OSI Model: Physical Layer

- Problem of NRZ Code
Long series of 0s or 1s do not induce a level change. Therefore, sender and receiver have to be in sync (either via internal clocks or via an additional clock line).
- Problem can be avoided by using **bit-stuffing**.

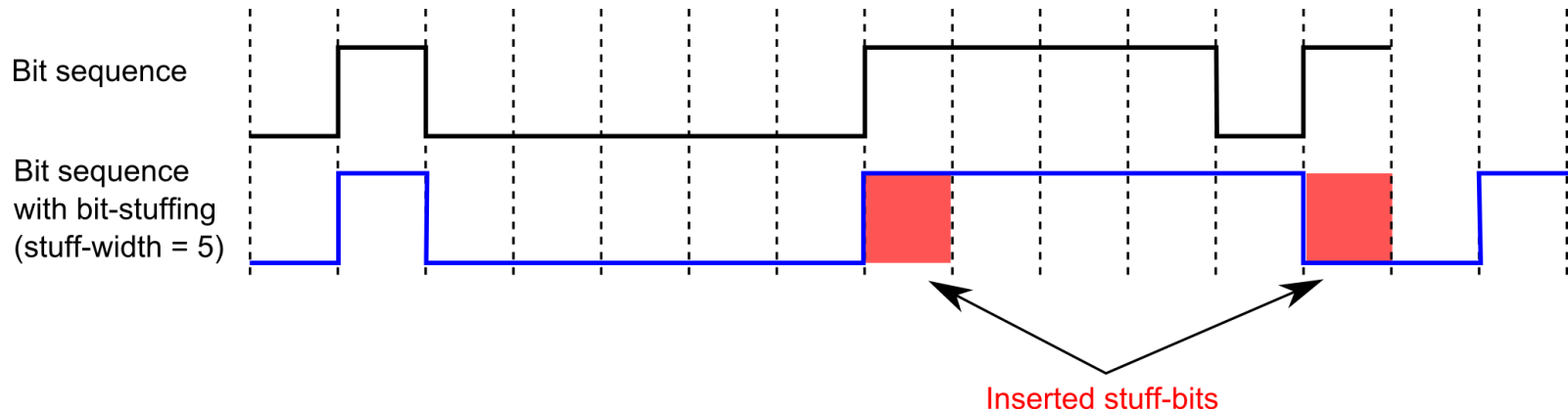

OSI Model: Data Link Layer

- In some protocols (e.g. IEEE 802) separated in two sub-layers:
 - 2a: Media Access Control (MAC)
 - 2b: Logical Link Control (LLC)
- Flow control
- Media access control
- Error detection (checksums, parity bits)

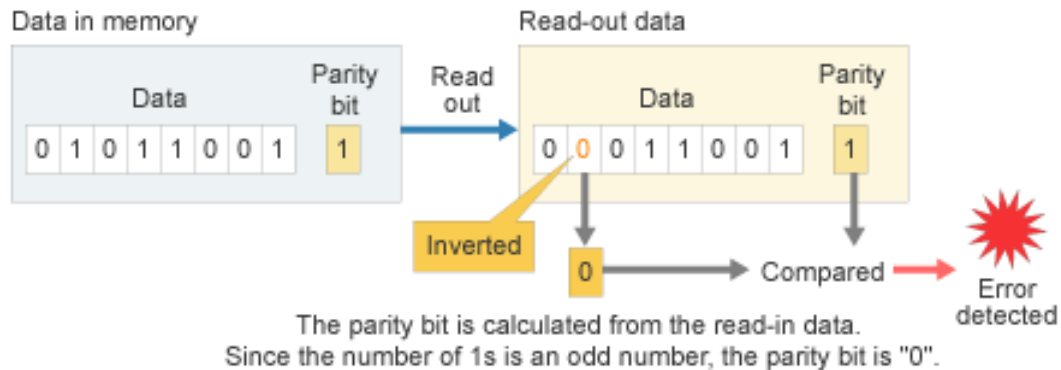

OSI Model: Application Layer

- Provides application-specific communication services
- Examples:
 - File Transfer (e.g. FTP)
 - E-Mail
 - Virtual Terminal
 - Remote Login
 - Voice-over-IP (VoIP)
 - Video-On-Demand

Content

1. Requirements
2. OSI Model
3. Network Topologies
4. Media Access Control Methods
5. Communication Protocols
 - a. SPI
 - b. TTA (TTP/A, TTP/C)
 - c. CAN
 - d. Realtime-Ethernet
 - e. Flexray

Network Topologies

- Important network topologies: (1) Star, (2) Bus and (3) Ring
- The Bus-Topology is wide-spread in real-time systems, as:
 - the effort for wiring is reduced
 - nodes can easily be added and/or removed

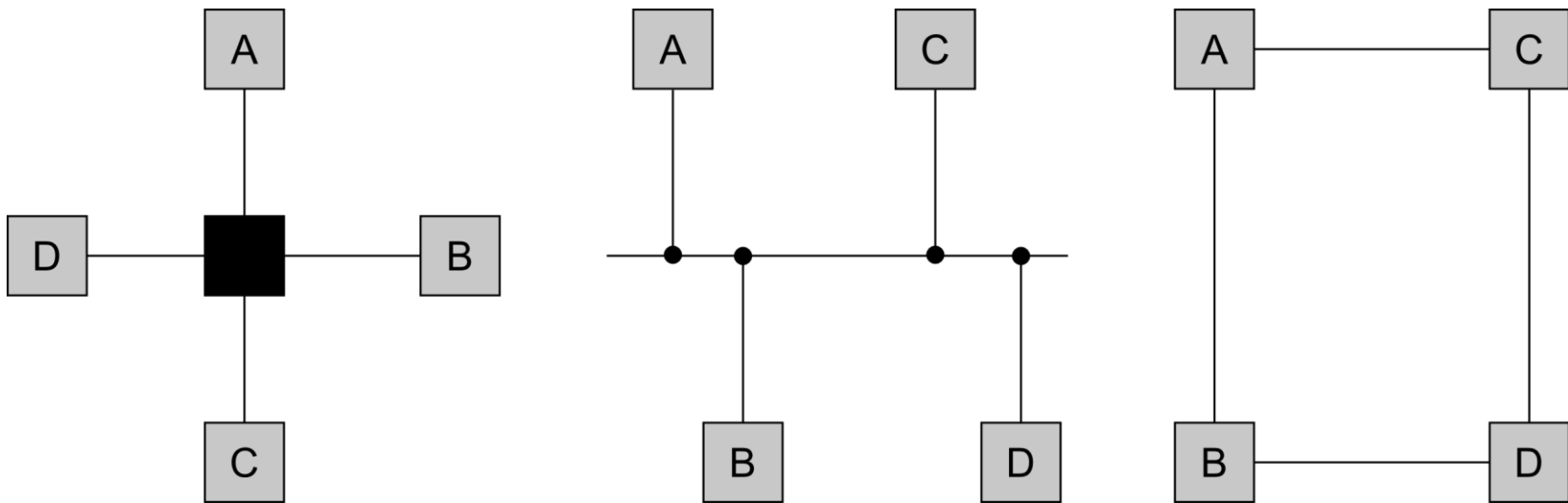

Content

1. Requirements
2. OSI Model
3. Network Topologies
4. Media Access Control Methods
5. Communication Protocols
 - a. SPI
 - b. TTA (TTP/A, TTP/C)
 - c. CAN
 - d. Realtime-Ethernet
 - e. Flexray

Overview

- Most of the time, the communication channel can **only** be used **exclusively** by **one** node
- Media access protocols are required to **assign** the communication channel to a node and to **resolve simultaneous** access

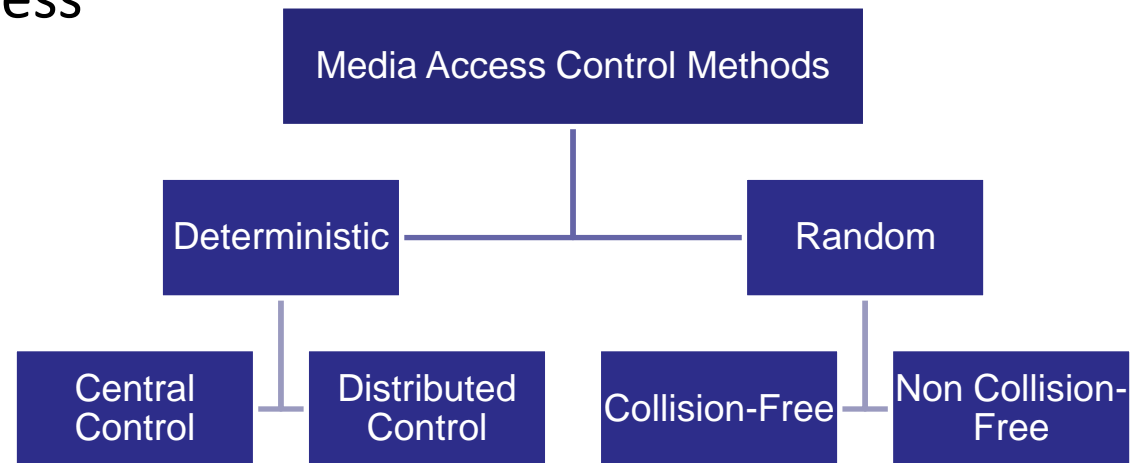

Deterministic Media Access Control Methods: Central Control

- Master-Slave communication
 - A master M periodically selects the slaves $S_1 \dots S_N$
 - Easy to implement
 - Deterministic latencies

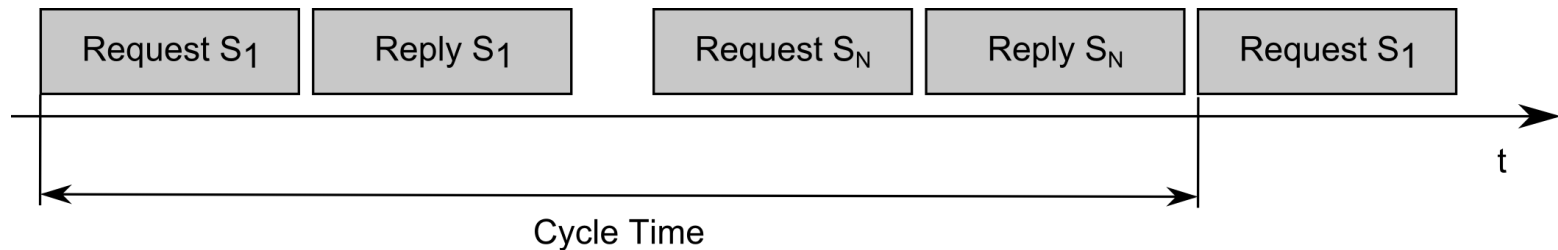

Deterministic Media Access Control Methods: Distributed Control

- Distributed media access control methods can be:
 - **Token-Based**
Media access is controlled via a special message – the *token*.
 - **Time-Based**
Media access is controlled via *time-slices* (Time Division Multiple Access – TDMA).

Random Media Access Control Methods

- **Carrier Sense Multiple Access / Collision Detection (CSMA/CD)**
 - Not collision free
 - Collisions are detected and signaled via a *Jam* signal
- **Carrier Sense Multiple Access / Collision Avoidance (CSMA/CA)**
 - Collision free
 - Use **arbitration** phase at beginning of transmission to select node with highest priority, lower priority nodes stop transmission and retry later.

Content

1. Requirements
2. OSI Model
3. Network Topologies
4. Media Access Control Methods
5. Communication Protocols
 - a. SPI
 - b. TTA (TTP/A, TTP/C)
 - c. CAN
 - d. Realtime-Ethernet
 - e. Flexray

Serial Peripheral Interface (SPI)



- SPI is a synchronous, serial data link standard developed by Motorola
- SPI is a master/slave bus
- SPI supports full-duplex communication
- Typical transmission frequencies: 1 – 100 MHz
- SPI uses 4 wires that convey the following signals:
 - SCLK: serial clock
 - MOSI: master output slave input
 - MISO: master in slave output
 - SS: slave select

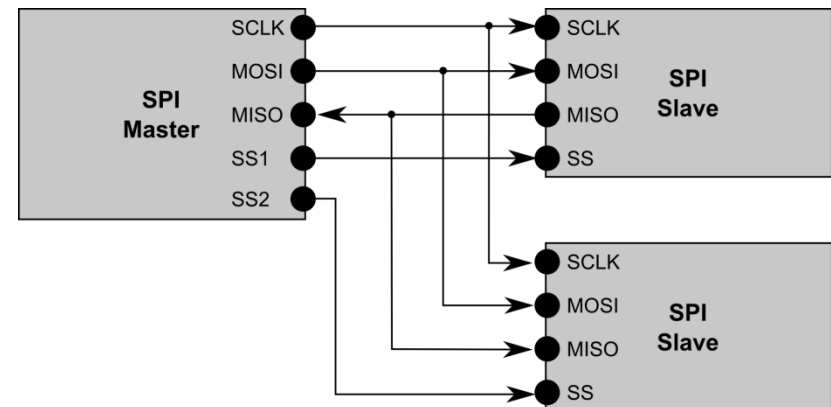

Serial Peripheral Interface (SPI)

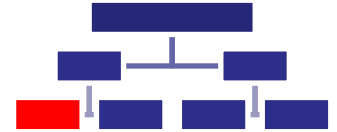

- The serial clock (SCLK) line synchronizes the data transmission on the two data lines (MOSI and MISO)
 - The master selects the slave for communication through the slave select (SS) lines
 - 4 communication modes are available that can be selected through the
 - CPOL (clock polarity) and
 - CPHA (clock phase)
- parameters of the SPI master register.



Serial Peripheral Interface (SPI)

CPHA = 0

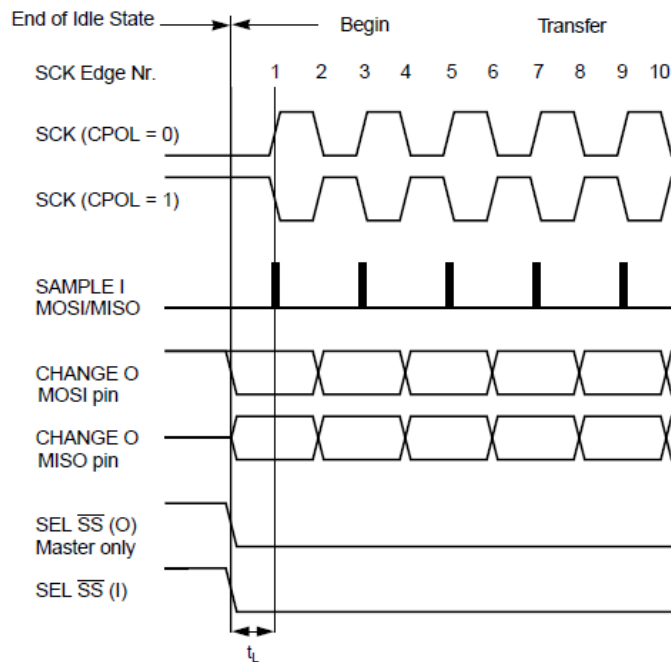

CPHA = 1

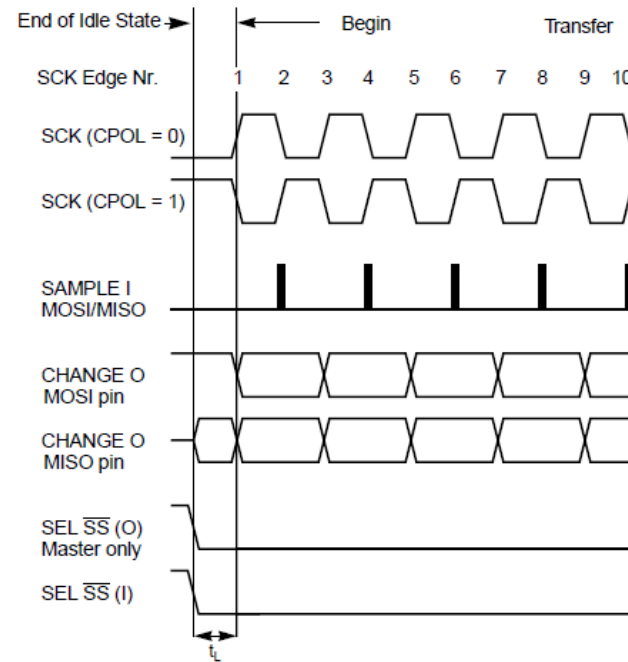

Source: Motorola SPI Block Guide, V03.06

Content

1. Requirements
2. OSI Model
3. Network Topologies
4. Media Access Control Methods
5. Communication Protocols
 - a. SPI
 - b. TTA (TTP/A, TTP/C)
 - c. CAN
 - d. Realtime-Ethernet
 - e. Flexray

Time-Triggered Architecture (TTA)

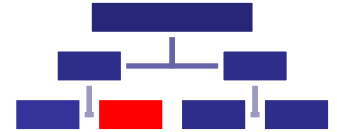

- The Time-Triggered Architecture (TTA) has been developed at the TU Wien (since the early 80s)
→ now managed by spin-off TTTech
- Defines two types of protocols:
 - **TTP/A**: Time-triggered field bus used to interconnect low-cost smart transducers
 - **TTP/C**: Fault-tolerant, time-triggered protocol for critical applications (e.g. X-by-Wire systems)
- A and C are classifiers based on the SAE classes (common in the automotive industry)
- TTP/A and C use TDMA (Time Division Multiple Access) for media access
- TTP/C used by Airbus A380 and Boeing Dreamliner

Time-Triggered Protocol (TTP/A)

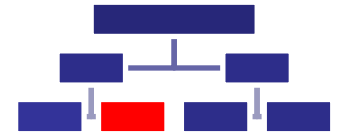

- TTP/A is used for non-safety-relevant systems
- TTP/A is a master/slave system
- Support of up to 255 slaves per bus
- Communication is divided in rounds and slots
 - Each round has a predefined sequence of slots (stored in Round Descriptor List – RODL)
 - Each round starts with a „Firework Byte“ send by the master
 - Each slot has a size of 1 Byte and is assigned to one message
- To increase fault tolerance a shadow master can be defined: a slave that replaces the master in case of failure

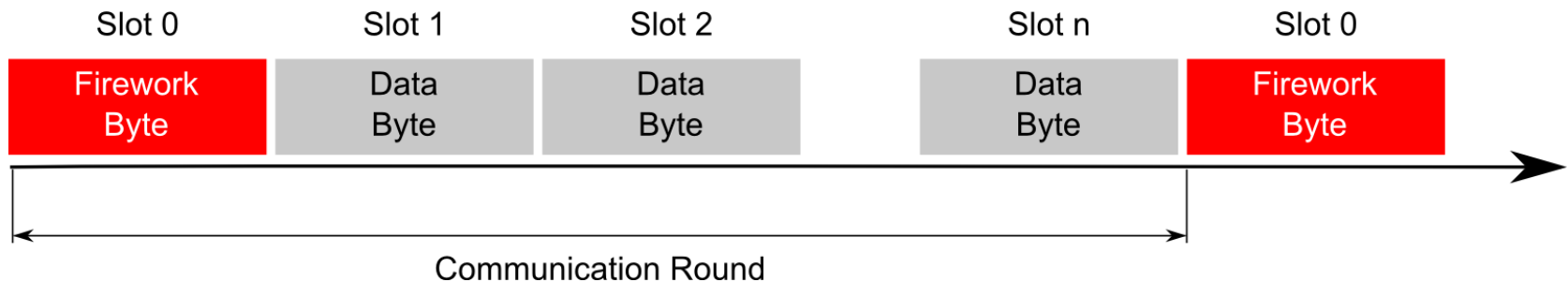

Time-Triggered Protocol (TTP/C)

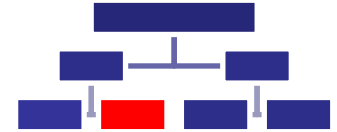

- TTP/C uses a global time base to synchronize the transmission of messages by different nodes
- Use of 2 channels possible for redundancy and fault tolerance
- Bandwidth: 25 MBit/s per channel
- Very high efficiency of 80 – 90 %
→ (high net transfer rate)
- Guardians control the access of a node to the physical medium
- Robust against „babbling idiots“ (due to Guardians)
- Topology: Bus or Star

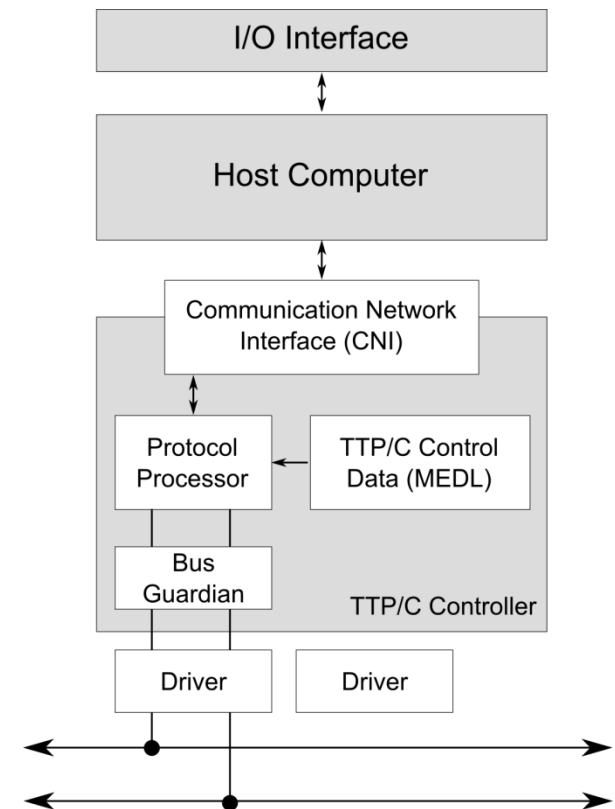

Time-Triggered Protocol (TTP/C)

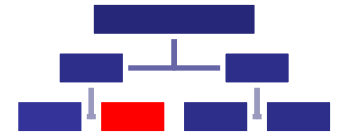

- Message Descriptor List (MEDL)
 - Points in time where data could be sent and the CNI address to read it.
 - Points in time where data could be received and the CNI address to store it.
- It is possible to configure more than 1 MEDL
 - e.g. in the phase of landing of a plane different sensors and actuators required different communication rates

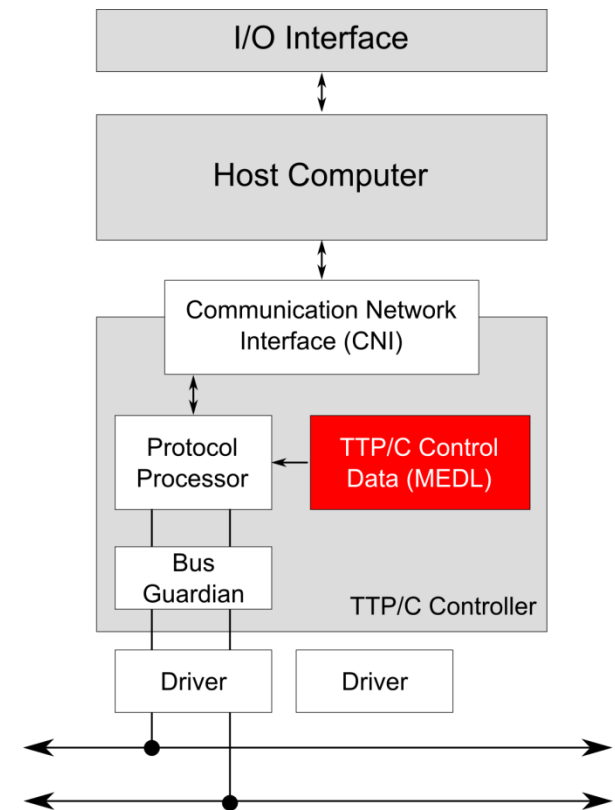

Time-Triggered Protocol (TTP/C)

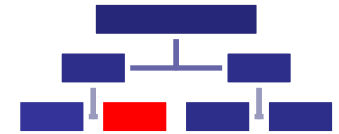

- Communication Network Interface (CNI)

- Interface between host and TTP/C controller
- Contains two data fields
 - Status/Control Area
Used for communication between host and CNI
 - Message Area
Used for exchanging data between host and CNI

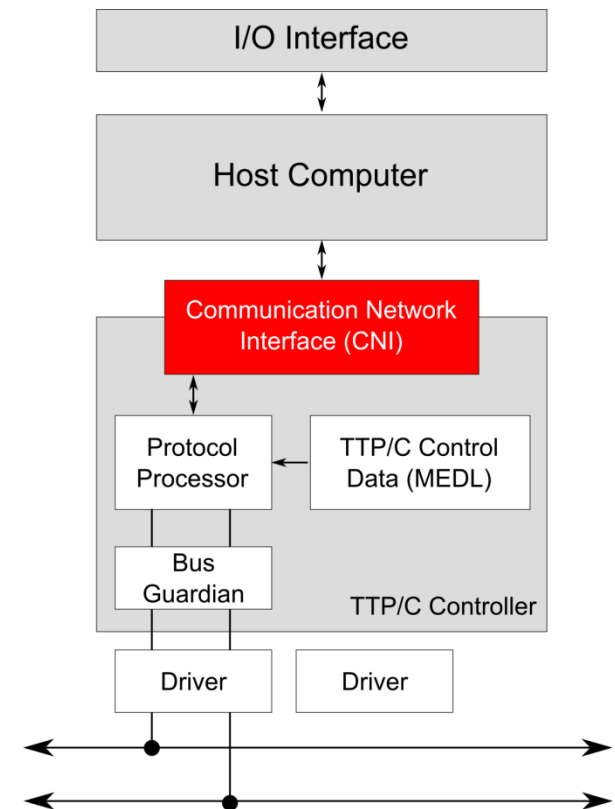

Content

1. Requirements
2. OSI Model
3. Network Topologies
4. Media Access Control Methods
5. Communication Protocols
 - a. SPI
 - b. TTA (TTP/A, TTP/C)
 - c. CAN
 - d. Realtime-Ethernet
 - e. Flexray

Controller Area Network (CAN)

- CAN (Controller Area Network) was developed in 1983 by Bosch
- CAN is a multi-master broadcast serial bus standard
- Topology: Bus
- CAN is message-based (each message is uniquely identified by an ID)
- Typically used in automotive and automation tasks/scenarios
- Max. bitrates depend on bus length
- CAN uses CSMA/CA for media access control

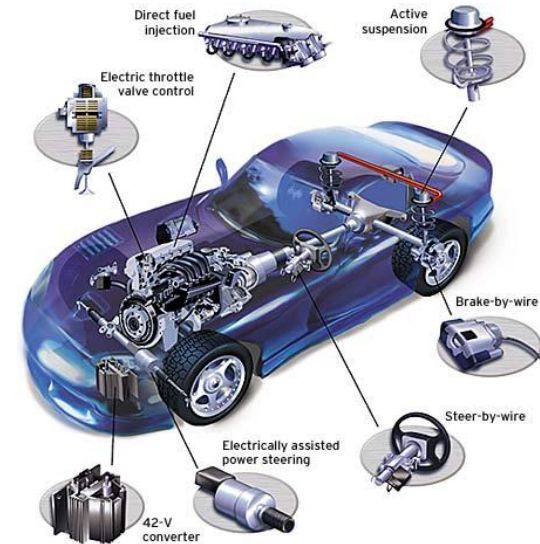
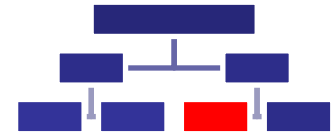

Max. Length	Max Bitrate
40 m	1 Mbit/s
100 m	500 kbit/s
500 m	125 kbit/s

Controller Area Network (CAN)

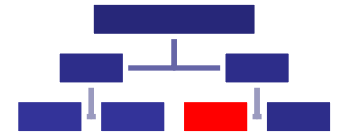

- There are several physical layer standards (e.g. ISO 11898-2 or SAE-J1939-11)
- ISO 11898-2 is the most wide-spread physical layer standard used in automotive and automation tasks
- Coding: NRZ-L (Non-Return-to-Zero-Level) with bit-stuffing (stuff-width = 5)
- Synchronization is done by dividing each bit of the message frame into four segments: Synchronization, Propagation Phase 1 Phase 2
- The „value“ of the bit is sampled between phase 1 and 2

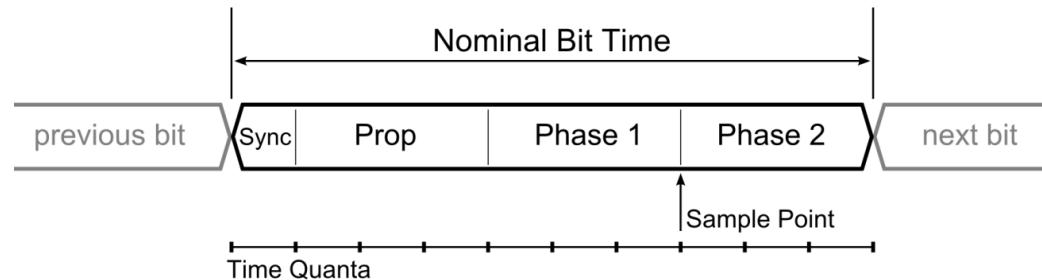

Controller Area Network (CAN)

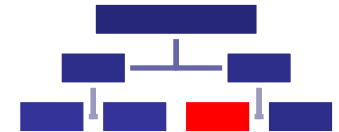

- The CAN bus must be terminated by an impedance of $120\ \Omega$ (matching the cable impedance)

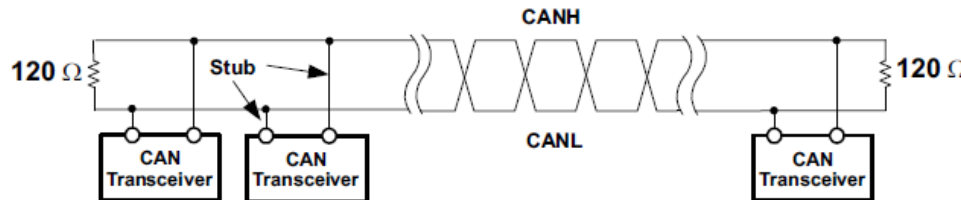

Bus termination
(see TI, SLLA270)

Example of unterminated and properly terminated bus signals (see TI, SLLA270)

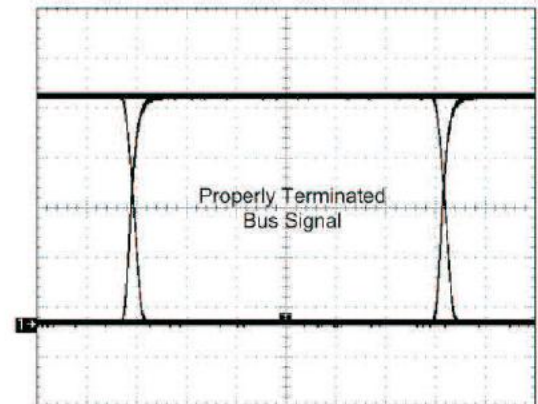
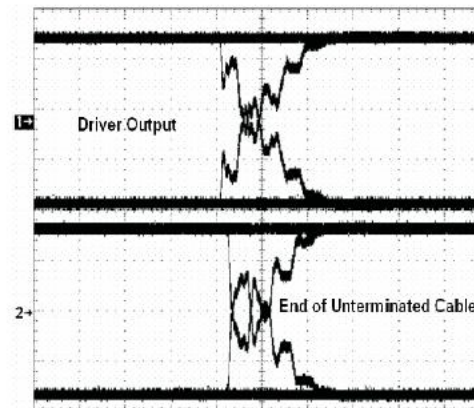

Controller Area Network (CAN)

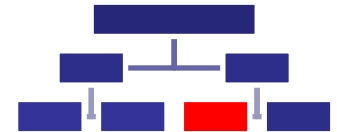

- CAN implements an **arbitration** scheme based on message identifiers to achieve collision avoidance (CA)
- Transmitted bits are either **dominant** (typically 0) or **recessive** (1).
- Arbitration takes place during transmission of identifier
- **Nodes** that **lost** arbitration **stop** transmission
- **Starvation** possible: Messages with higher priority suppress messages with lower priorities

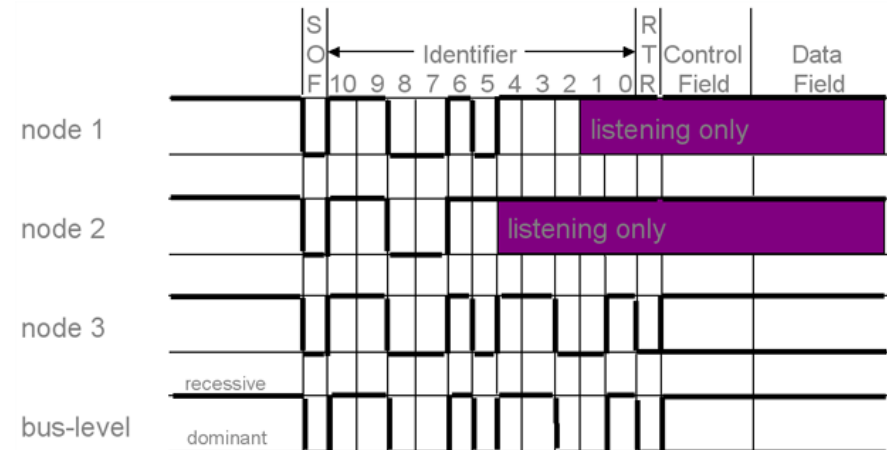

Node 3 wins arbitration and transmits his data.

Controller Area Network (CAN)

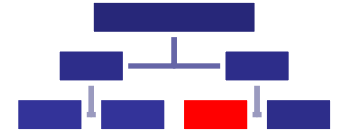

- CAN defines four types of frames:
 - Data frame: Used for data transmission
 - Remote frame: Used for requesting data
 - Error frame: Used to notify errors
 - Overload frame: Enforces delay before next data or remote frame
- Two types of identifier formats exist:

Standard CAN (11-Bit identifier)

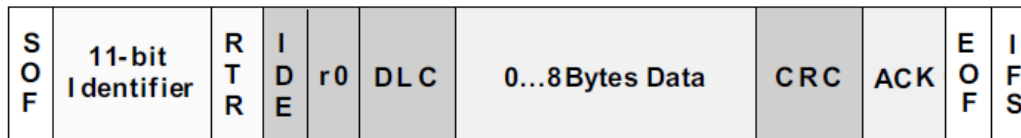

Extended CAN (29-Bit identifier)

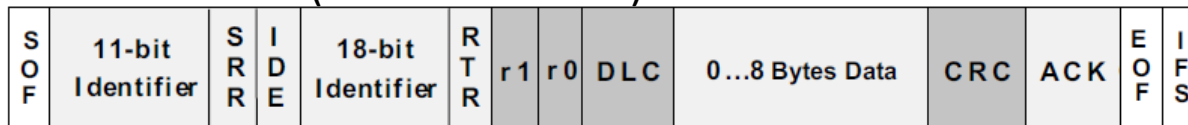

Source: TI, SLLA270

Content

1. Requirements
2. OSI Model
3. Network Topologies
4. Media Access Control Methods
5. Communication Protocols
 - a. SPI
 - b. TTA (TTP/A, TTP/C)
 - c. CAN
 - d. Realtime-Ethernet
 - e. Flexray

Realtime-Ethernet

- **Goal**
To use standard ethernet hardware and infrastructure for real-time applications (e.g. automation).
- **Reasons**
 - Cheap hardware
 - High availability of hardware
 - No additional infrastructure costs (existing wires, switches, etc. can be used)
- **Problem**
Standard Ethernet (IEEE 802.3) does not support realtime applications.

Realtime-Ethernet: IEEE 802.3 Overview



- IEEE 802.3 uses CSMA/CD
- Collision:
 - Nodes stop transmission
 - Nodes send Jam signal
 - Nodes wait backoff time then try to retransmit

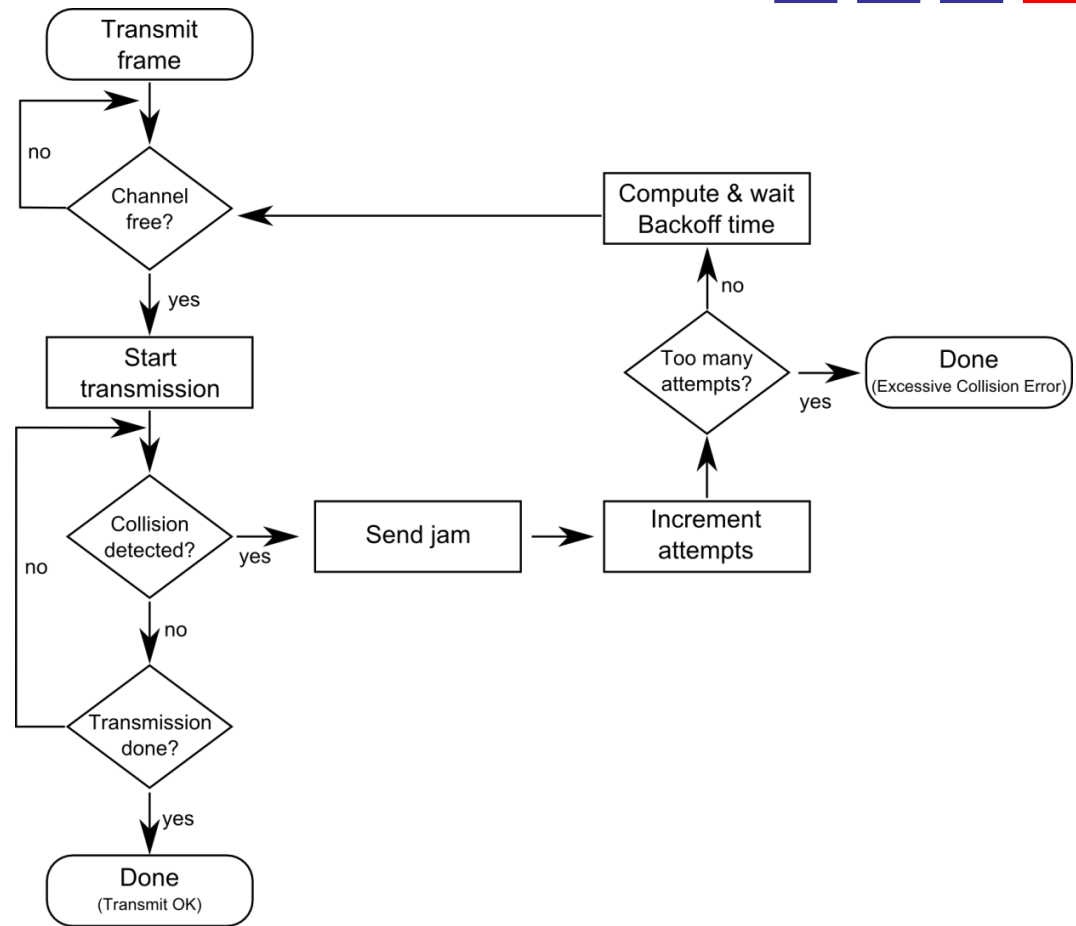

Realtime-Ethernet: IEEE 802.3 Overview

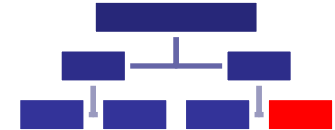

Parameters	MAC data rate		
	Up to and including 100 Mb/s	1 Gb/s	10 Gb/s
slotTime	512 bit times	4096 bit times	not applicable
interPacketGap ^a	96 bits	96 bits	96 bits
attemptLimit	16	16	not applicable
backoffLimit	10	10	not applicable
jamSize	32 bits	32 bits	not applicable
maxBasicFrameSize	1518 octets	1518 octets	1518 octets
maxEnvelopeFrameSize	2000 octets	2000 octets	2000 octets
minFrameSize	512 bits (64 octets)	512 bits (64 octets)	512 bits (64 octets)
burstLimit	not applicable	65 536 bits	not applicable
ipgStretchRatio	not applicable	not applicable	104 bits

^aReferences to interFrameGap or interFrameSpacing in other clauses (e.g., 13, 35, and 42) shall be interpreted as interPacketGap

Source: IEEE 802.3 – 2008, Part 3

- JAM Signal
 - Notifies other nodes of collision
 - Sequence of 1s and 0s (starting with a 1)
- Truncated Exponential Backoff
 - Integer multiple of slot time (e.g. 5.12 μ s for 100Mbit/s)
 - Integer multiple of n -th retransmission picked from uniform distribution in range:
 $0 \leq r < 2^k$
 where $k = \min(n, \text{backoffLimit})$

Realtime-Ethernet

- Various approaches exist to overcome the limitations of IEEE 802.3 for realtime applications.

Examples:

- EtherCAT (Beckhoff)
- Profinet (Siemens)
- Time-Triggered Ethernet

Realtime-Ethernet: EtherCAT

- Suitable for hard and soft realtime requirements
- EtherCAT messages conform with the Ethernet standard
- Messages are sent by a master and are forwarded by the slaves
- Each slave extracts relevant user data or inserts them
- The EtherCAT slaves process incoming messages “on-the-fly” which reduces the latency

Realtime-Ethernet: Profinet



- Standardized in IEC61158 and IEC61784
- Three protocol levels with different reaction times
 - TCP/IP: ~ 100 ms
 - Real-Time Protocol: < 10ms
 - Isochronous Real-Time (IRT): < 1ms
uses PTP for time synchronization
- Profinet IRT uses pre-defined and reserved time slots to transmit realtime data
- In the rest of the time, standard Ethernet is used

Realtime-Ethernet: Time-Triggered Ethernet

- Uses a global time base to provide time-triggered communication over Ethernet
- Three different traffic types are supported:
 - Time-Triggered (TT)
TT messages are send at predefined times.
 - Rate-Constrained (RC)
RC messages guarantee that bandwidth is predefined for each application and that delays have defined limits. RC messages do not depend on global time base (simultaneous sending possible).
 - Best-Effort (BE)
BE messages use remaining bandwidth. No guaranteed delays.
- Uses special switches to ensure low delays (e.g. TT messages are forwarded with a constant delay, while RC are buffered)

Content

1. Requirements
2. OSI Model
3. Network Topologies
4. Media Access Control Methods
5. Communication Protocols
 - a. SPI
 - b. TTA (TTP/A, TTP/C)
 - c. CAN
 - d. Realtime-Ethernet
 - e. Flexray

FlexRay

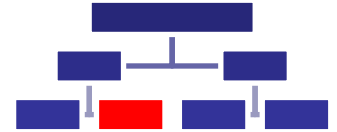

- FlexRay Consortium (2000-2010): BMW, Daimler, Motorola (Freescale), Philips (NXP), Bosch, GM, VW
- FlexRay currently under conversion into ISO standard
- Main Properties:
 - Bandwidth: 10 Mbit/s
 - Time- and event-triggered data packages
 - Fault-tolerant (redundant channels, e.g. for X-by-wire systems)
- Used by premium cars (e.g. Audi A8)



FlexRay

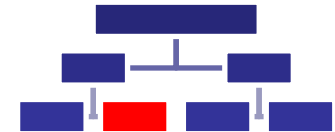

- Typical Network-Topology: Active Star
- Bus or hybrid topologies are also possible
- 1 or 2 channel topology – depending on fault tolerance / bandwidth requirements

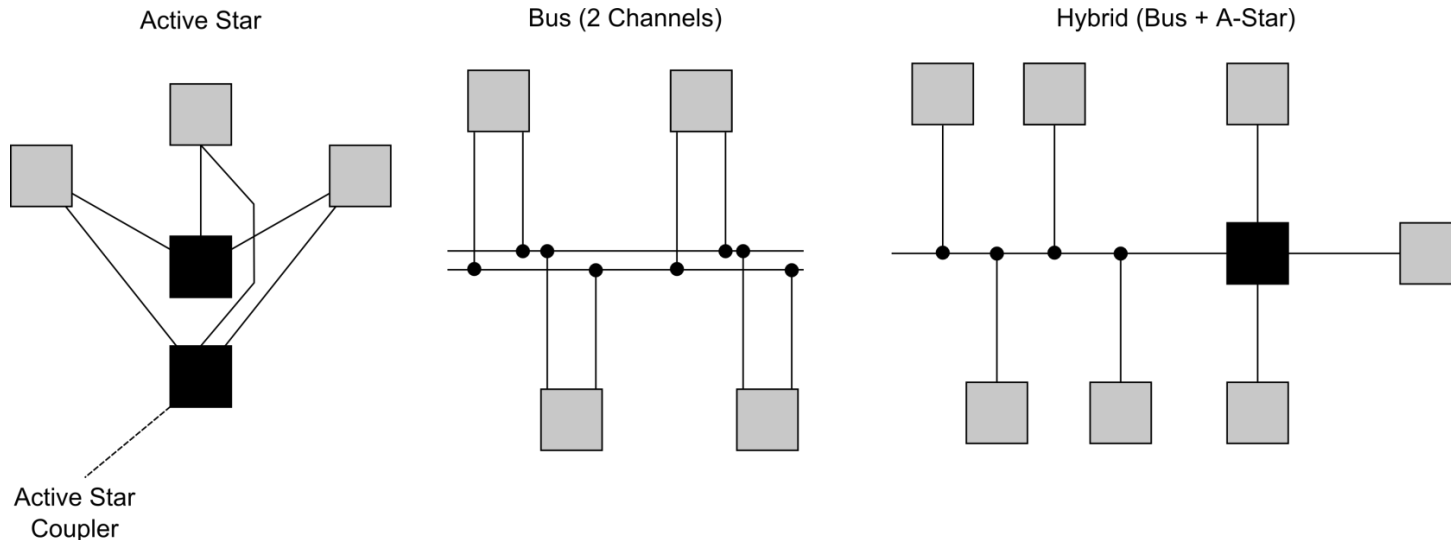

FlexRay

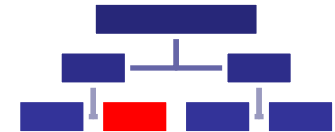

- FlexRay communication is divided in:
 - a **static** segment: Deterministic media access based on TDMA
 - a **dynamic** segment: Non-deterministic media access based on FTDMA (Flexible Time Division Multiple Access)
- Time base is established at wake-up of control units.

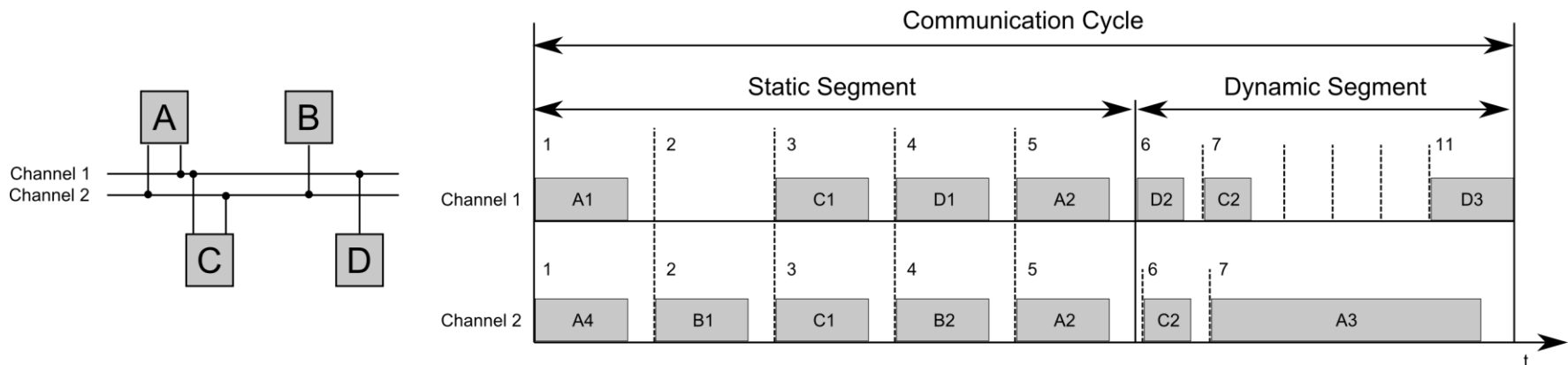

FlexRay

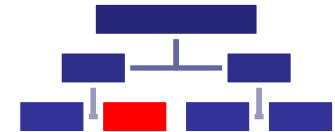

- A FlexRay **frame** is divided into **three** segments: Header, Payload and Trailer
- **Variable payload** length from 0 to 254 Bytes
- **CRC** for **header** (partly) and **payload**
- **Frame ID**: Defines the slot in which the frame should be transmitted (Range: 1-2047, ID 0 is an invalid frame ID)
- **Payload Length**: Payload data bytes / 2

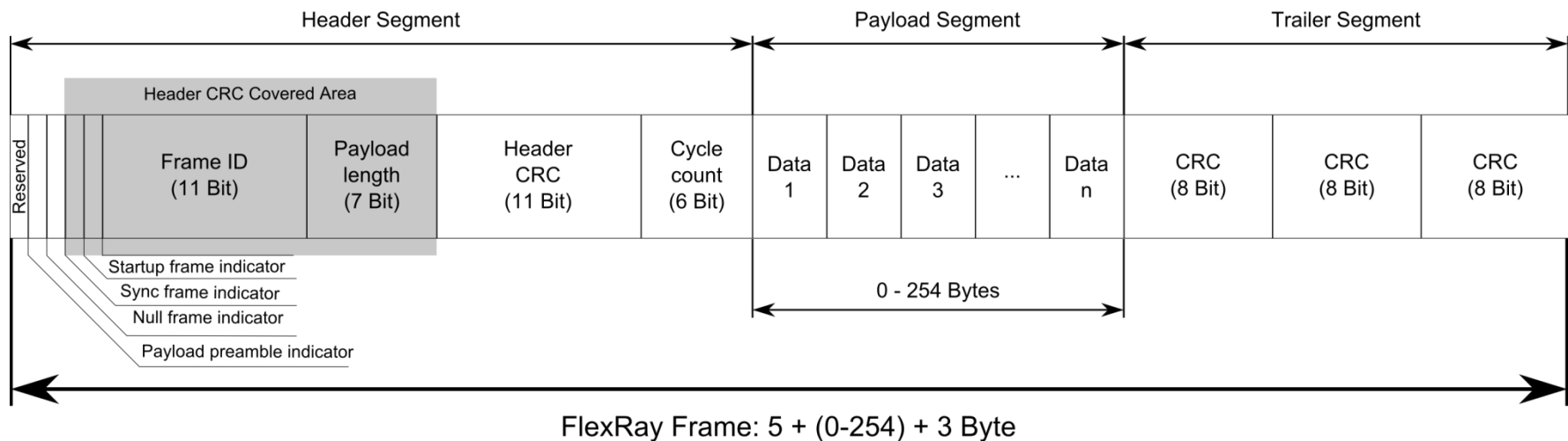

Summary

- A large variety of communication protocols exist
- Suitable protocol has to be selected based on requirements of application (e.g. costs, hard/soft realtime, etc.)

Literatur

- Konrad Reif, Automobilelektronik, 3. Auflage, Vieweg, 2009
- Andrew Tanenbaum, Computer Networks, Pearson
- Time-Triggered Ethernet & TTP: <http://www.tttech.com>
- SPI: The SPI Block Guide V03.06 (from Motorola)
- CAN: <http://www.can-cia.org>
- Ethernet: <http://www.ieee802.org>
- TTP/A, TTP/C: Introduction to TTP, Kevin Hipp, Seminar Paper